

SPEC. NUMBER
NO. J01-201909PRODUCT GROUP
TFT-LCDREV.
POISSUE DATE
2019.09PAGE
1 OF 24

B4 QT070WVM-NH0 Product Specification



Nanjing Juzhen International Co.,Ltd

Contents

No.	Items	Page
1.0	General Description	3
2.0	Absolute Maximum ratings	5
3.0	Electrical specifications.	6
4.0	Interface Connection	8
5.0	Data Input Format	9
6.0	Scanning direction	11
7.0	Power Sequence	12
8.0	Optical specifications.	13
9.0	Mechanical Characteristics	18
10.0	Reliability Test	19
11.0	Handling & Cautions	20
12.0	Mechanical Outline Dimension	23

1.0 GENERAL DESCRIPTION

1.0.1 Introduction

QT070WVM-NH0 is a color active matrix TFT LCD module using amorphous silicon TFT's (Thin Film Transistors) as an active switching devices. This module has a 7.0 inch diagonally measured active area with WVGA resolutions (800 horizontal by 480 vertical pixel array). Each pixel is divided into RED, GREEN, BLUE dots which are arranged in vertical stripe and this module can display 16.7M colors.

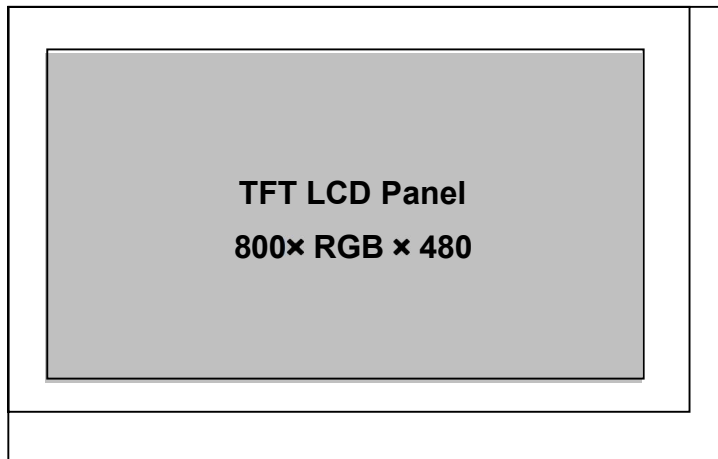

1.0.2 Features

- Thin and light weight
- 0.5 t Glass (Total 1.0t)
- IC(COG)
- support 16.7M colors

1.0.3 Application

- Washing machine

1.0.4 General Specification

< Table 1. General Specifications >

Parameter	Specification	Unit	Remarks
Active area	153.84 (H) × 85.632 (V)	mm	
Number of pixels	800(H) × 480(V)	Pixels	
Pixel pitch	0.0641(H) × 0.1784(V)	mm	1 Dot
Pixel arrangement	RGB Vertical stripe		
Display colors	16.7M	Colors	
Driver IC	Source driver : EK9716BD4 Gate driver : EK73002AB2		
Display mode	Normally White		
Dimensional outline	164.9 (W)× 100(H)× 7.15(T)	mm	10.0max
Weight	160	g	
Surface treatment	Haze 25%, 3H		
Back-light	LED		24*LED

2.0 ABSOLUTE MAXIMUM RATINGS

The followings are maximum values which, if exceed, may cause faulty operation or damage to the unit. The operational and non-operational maximum voltage and current values are listed in Table 2.

< Table 2. Environment Absolute Maximum Ratings> [Ta =25± 2 °C]

Parameter	Symbol	Min.	Max.	Unit	Remarks
Supply voltage for logic	DVDD	-0.5	+5	V	Ta = 25 °C Note 1
Supply voltage for I/O	AVDD	-0.5	+15	V	
Operating Temperature	TOP	-20	+70	°C	Environment Temperature
Storage Temperature	TST	-30	+80	°C	
Storage Humidity	Hst	.	90	%RH	

Note:

1.while environment temperature is 25°C and actual LCM surface temperature is no more than 40°C And JUZHEN is not responsible for product problems beyond the use conditions .

3.0 ELECTRICAL SPECIFICATION

3.0.1 TFT LCD Module

< Table 3. LCD Module Electrical Specifications >

[Ta =25± 2 °C]

Parameter	Symbol	Min	Typ	Max	Unit
Supply voltage for logic	DVDD	2.7	3.3	3.6	V
Input Current for DVDD	Ivdd	-	16	25	mA
Analog supply voltage	Avdd	10.1	11.0	11.2	V
Input Current for AVDD	Iavdd	-	25	30	mA
Input voltage 'H' level	VIH	0.7*DVDD	-	DVDD	V
Input voltage 'L' level	VIL	0	-	0.3*DVDD	V
TFT Gate ON Voltage	VGH	16	16.2	18	V
TFT Gate OFF Voltage	VGL	-7.8	-7	-6.8	V
TFT Common Electrode Voltage	VCOM	3,2	3.8	4.2	V

Notes :

1. VGH is TFT Gate operating voltage.
2. VGL is TFT Gate operating voltage. The low voltage level of VGL signal must be fluctuates with same phase as Vcom.
3. Vcom must be adjusted to optimize display quality, as Crosstalk and Contrast Ratio etc..
4. The value is just the reference value. The customer can optimize the setting value by the different D-IC
5. The supply voltage is measured and specified at the interface connector of LCM.
The current draw and power consumption specified is for VDD=3.3V, Frame rate f_v=60Hz
Test Pattern of power supply current

a) Typ : Mosaic 7 x 5 Pattern(L0/L255)

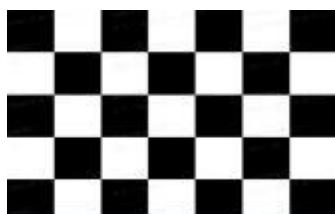

b) Max : H 1 line



3.0.2 Back-light Unit

< Table 4. LED Driving guideline specifications >

Ta=25+/-2°C

Parameter		Min.	Typ.	Max.	Unit	Remarks
Power supply voltage for Back light	V _{LED}		9.3	10.2	V	
Power supply Current for Back light	I _{LED}		160		mA	
Power supply for Back light	P _{LED}		1.488		W	Note 1

Notes : 1. Calculator Value for reference $I_{LED} \times V_{LED} = P_{LED}$

4.0 INTERFACE CONNECTION.

The connector interface pin assignments are listed in Table 5.

<Table 5. Pin Assignments for the Interface Connector>

PIN No.	Symbol	Function	PIN No.	Symbol	Function
1	VLED+	LED ANODE	26	G1	Green data input 1
2	VLED+	LED ANODE	27	G0	Green data input 0
3	VLED-	LED CATHODE	28	R7	Red data input 7
4	VLED-	LED CATHODE	29	R6	Red data input 6
5	GND	Ground	30	R5	Red data input 5
6	VCOM	The liquid crystal molecules deflection reference voltage	31	R4	Red data input 4
7	DVDD	A power supply for the logic power	32	R3	Red data input 3
8	MODE	H:DE mode L:SYNC mode	33	R2	Red data input 2
9	DE	Data input enable	34	R1	Red data input 1
10	VS	Vertical sync signal	35	R0	Red data input 0
11	HS	Horizontal sync signal	36	GND	Ground
12	B7	Blue data input 7	37	DCLK	Clock signal
13	B6	Blue data input 6	38	GND	Power supply for Gate on output
14	B5	Blue data input 5	39	L/R	Vertical display mode control signal
15	B4	Blue data input 4	40	U/D	Horizontal display mode control signal
16	B3	Blue data input 3	41	VGH	Power supply for Gate on output
17	B2	Blue data input 2	42	VGL	Power supply for Gate off output
18	B1	Blue data input 1	43	AVDD	Analog Power Supply
19	B0	Blue data input 0	44	RESET	LCM Reset pin
20	G7	Green data input 7	45	NC	NC
21	G6	Green data input 6	46	VCOM	The liquid crystal molecules deflection reference voltage
22	G5	Green data input 5	47	DITHB	H:6bit resolution L:8bit resolution
23	G4	Green data input 4	48	GND	Ground
24	G3	Green data input 3	49	NC	NC
25	G2	Green data input 2	50	NC	NC

5.0 Data Input Format

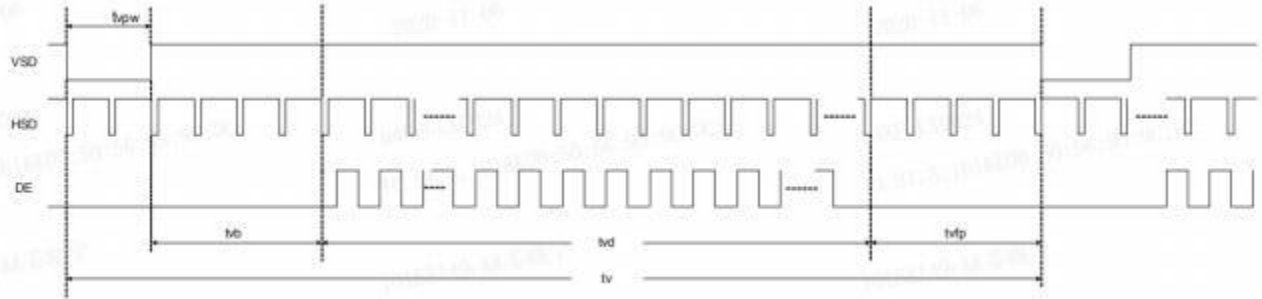

Vertical input timing

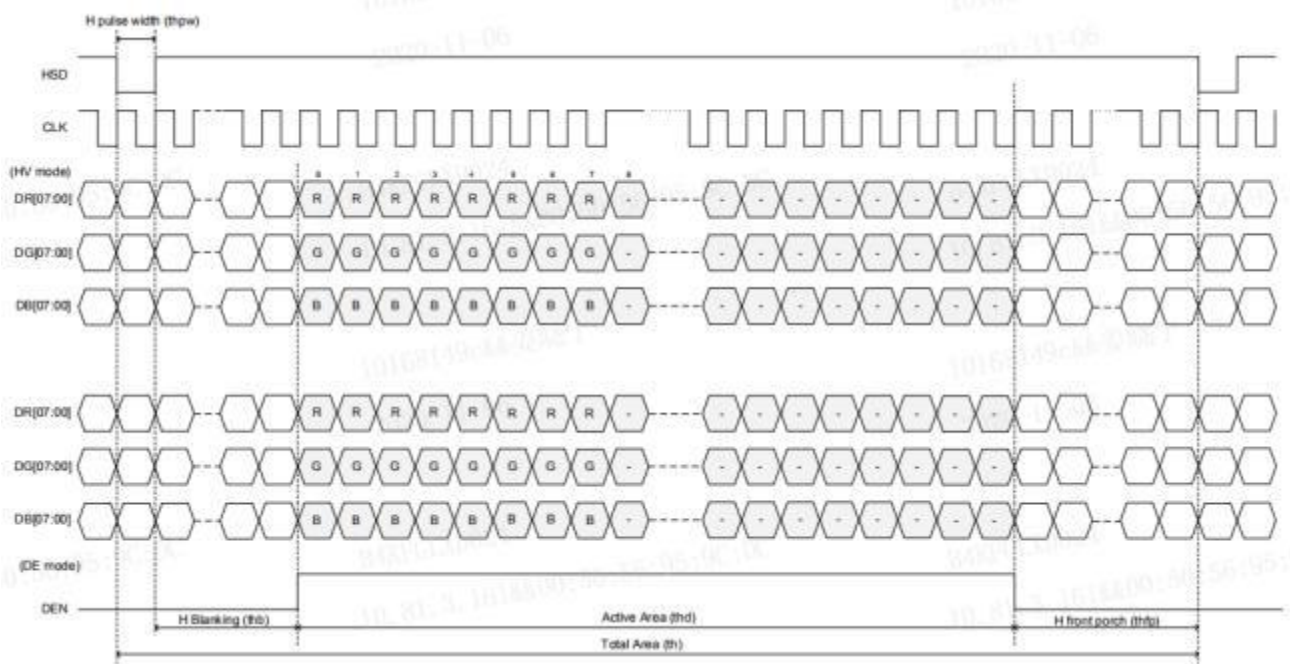

Horizontal input timing

<Table 6. Horizontal input timing

Parameter	Symbol	Value			Unit	Note
Horizontal display area	thd	800			DCLK	
DCLK frequency	fclk	Min.	Typ.	Max	MHz	
		28.2	29.2	46.5		
1 Horizontal Line	th	908	928	1088	DCLK	thb+thpw=88 DCLK is fixed.
HSD pulse width	thpw	1	48	87		
HSD Back Porch (Blanking)	thb	87	40	1		
HSD Front Porch	thfp	20	40	200		

<Table 7. Vertical input timing

Parameter	Symbol	Min.	Typ.	Max.	Unit	Note
Vertical display area	tvd	480			H	
VSD period time	tv	517	525	712	H	tvpw+tvb=32H Is fixed
VSD pulse width	tvpw	1	1	3	H	
VSD Back Porch (Blanking)	tvb	31	31	29	H	
VSD Front Porch	tvfp	5	13	200	H	

6.0 Scanning direction

When UD= "L" ,LR= "H" , The scanning direction is from up to down and from left to right.

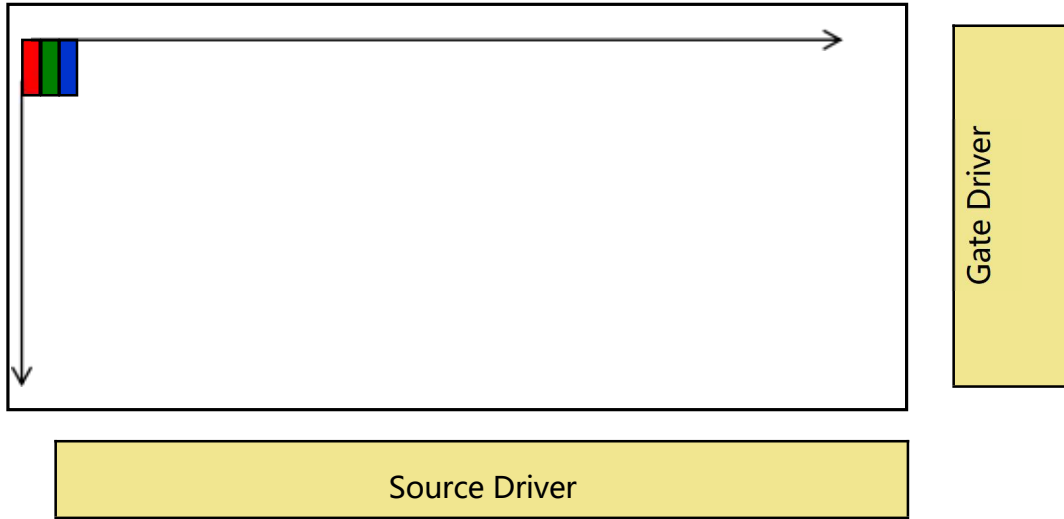

Scan Control Input		Scanning Direction
UD	LR	
L	H	Up to Down,Left to Right
H	L	Down to Up,Right to Left
L	L	Up to Down,Right to Left
H	H	Down to Up,Left to Right

7.0 POWER SEQUENCE

To prevent a latch-up or DC operation of the LCD module, the power on/off sequence shall be as shown in below

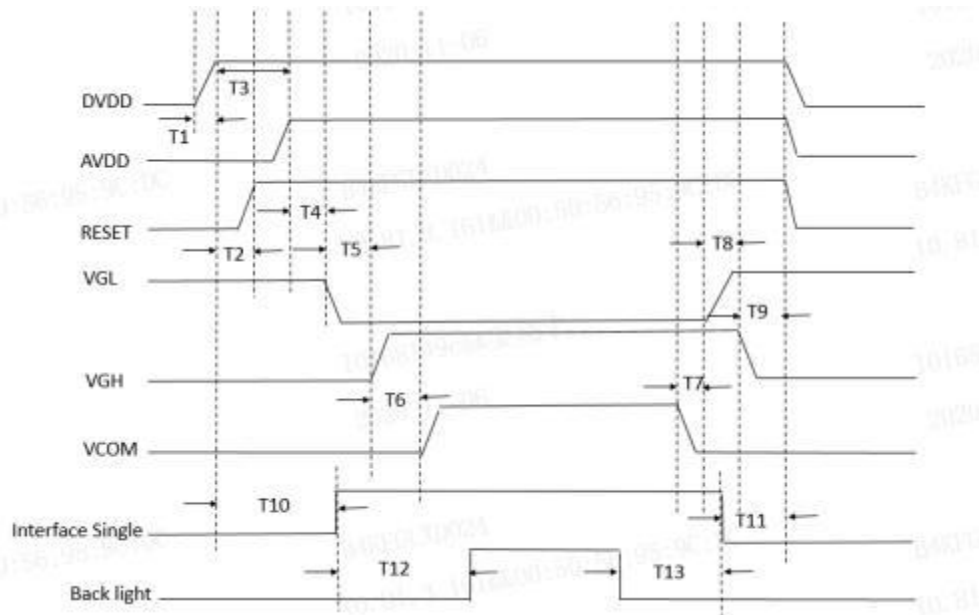

Parameter	Values			Units
	Min	Typ	Max	
T1	0	-	20	ms
T2	-	10	-	ms
T3	16	-	-	ms
T4	-	16	-	ms
T5	-	16	-	ms
T6	-	16	-	ms
T7	-	16	-	ms
T8	-	16	-	ms
T9	-	16	-	ms
T10	150	-	-	ms
T11	150	-	-	ms
T12	300	-	-	ms
T13	300	-	-	ms

8.0 OPTICAL SPECIFICATION

8.0.1 Overview

The test of Optical specifications shall be measured in a dark room (ambient luminance ≤ 1 lux and temperature = $25 \pm 2^\circ\text{C}$) with the equipment of Luminance meter system (Goniometer system and TOPCON BM-7) and test unit shall be located at an approximate distance 50cm from the LCD surface at a viewing angle of θ and Φ equal to 0° . We refer to $\theta=0^\circ$ ($=\theta_3$) as the 3 o'clock direction (the "right"), $\theta=90^\circ$ ($=\theta_{12}$) as the 12 o'clock direction ("upward"), $\theta=180^\circ$ ($=\theta_9$) as the 9 o'clock direction ("left") and $\theta=270^\circ$ ($=\theta_6$) as the 6 o'clock direction ("bottom"). While scanning θ and/or Φ , the center of the measuring spot on the Display surface shall stay fixed.

Optimum viewing angle direction is 6 o'clock.

<Table 8. Optical Specifications>

Parameter		Symbol	Condition	Min.	Typ.	Max.	Unit	Remark
Viewing Angle range	Horizontal	θ_3	CR > 10	60	70	..	Deg.	Note 1
		θ_9		60	70	..	Deg.	
	Vertical	θ_{12}		50	60	..	Deg.	
		θ_6		60	70	..	Deg.	
Luminance Contrast ratio		CR	$\theta = 0^\circ$.	500	.		Note 2
Luminance of White	Center	Y_w	$\theta = 0^\circ$	280	350	.	cd/m ²	Note 3
White Luminance uniformity	9 Points	ΔY_9		75	.	.	%	Note 4
Color Gamut (C light)	NTSC	CIE1931	$\theta = 0^\circ$.	50	.	%	Note 5
Reproduction of color	White	W_x	$\theta = 0^\circ$	0.254	0.304	0.354	.	
		W_y		0.278	0.328	0.378	.	
Response Time		$Tr+Td$	$T_a=25^\circ\text{C}$ $\theta = 0^\circ$.	25	40	ms	Note 6

Notes : 1. Viewing angle is the angle at which the contrast ratio is greater than 10. The viewing angles are determined for the horizontal or 3, 9 o'clock direction and the vertical or 6, 12 o'clock direction with respect to the optical axis which is normal to the LCD surface (see FIGURE 1).

2. Contrast measurements shall be made at viewing angle of $\Theta = 0$ and at the center of the LCD surface. Luminance shall be measured with all pixels in the view field set first to white, then to the dark (black) state . (see FIGURE 1) Luminance Contrast Ratio (CR) is defined mathematically.

$$CR = \frac{\text{Luminance when displaying a white raster}}{\text{Luminance when displaying a black raster}}$$

3. Luminance of white is defined as luminance values of center of the LCD surface. Luminance shall be measured with all pixels in the view field set first to white. This measurement shall be taken at the locations shown in FIGURE 2 for a total of the measurements per display. The luminance is measured by TOPCON BM-7 when the LED current is set at 20mA.

4. The White luminance uniformity on LCD surface is then expressed as : $\Delta Y = \frac{\text{Minimum Luminance of 9 points}}{\text{Maximum Luminance of 9 points}}$ (See FIGURE 2).

5. The color chromaticity coordinates specified in Table 5. shall be calculated from the spectral data measured with all pixels first in red, green, blue and white. Measurements shall be made at the center of the panel.

6. The electro-optical response time measurements shall be made as FIGURE 3 by switching the "data" input signal ON and OFF. The times needed for the luminance to change from 10% to 90% is T_r , and 90% to 10% is T_d .

8.02 BLU LED Specifications

LED Model: 聚飞01.JT.CB314BA-B-P 色块: A2

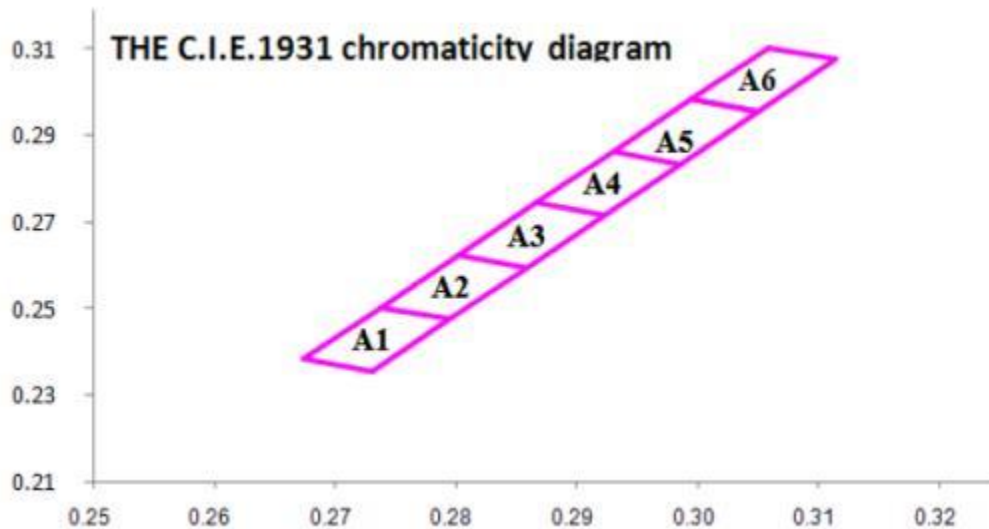

LED Bin Code:

Bin Code	X	Y
A2	0.2802	0.2623
	0.2738	0.2503
	0.2795	0.2475
	0.2859	0.2595

8.0.3 Optical measurements

Figure 1. Measurement Set Up

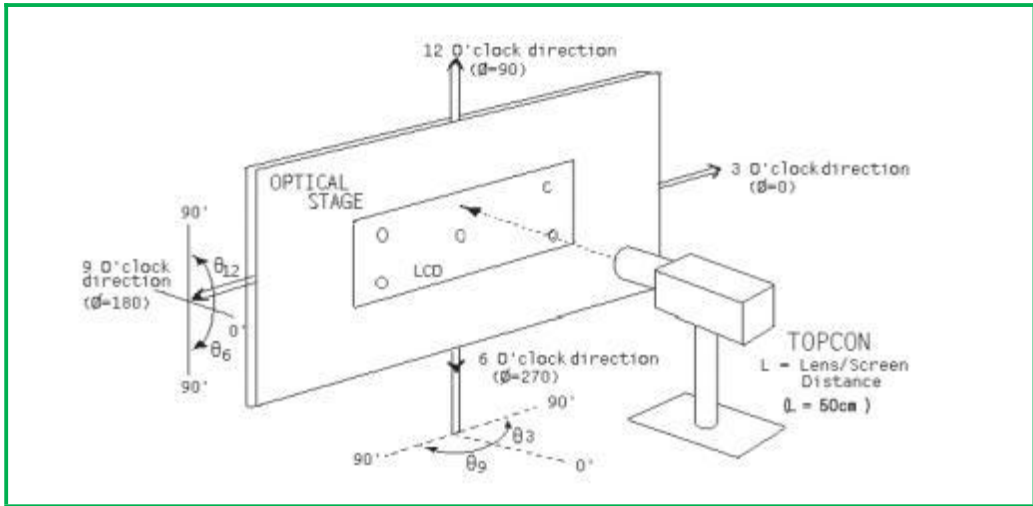

Figure 2. White Luminance and Uniformity Measurement Locations (9 points)

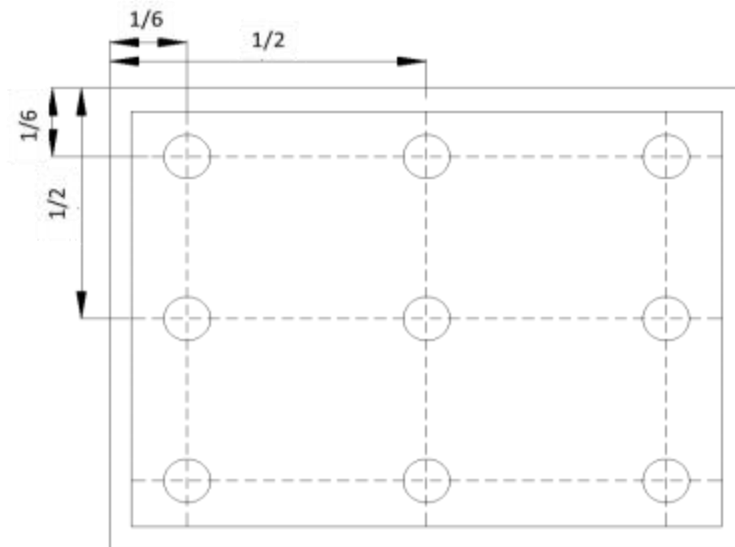
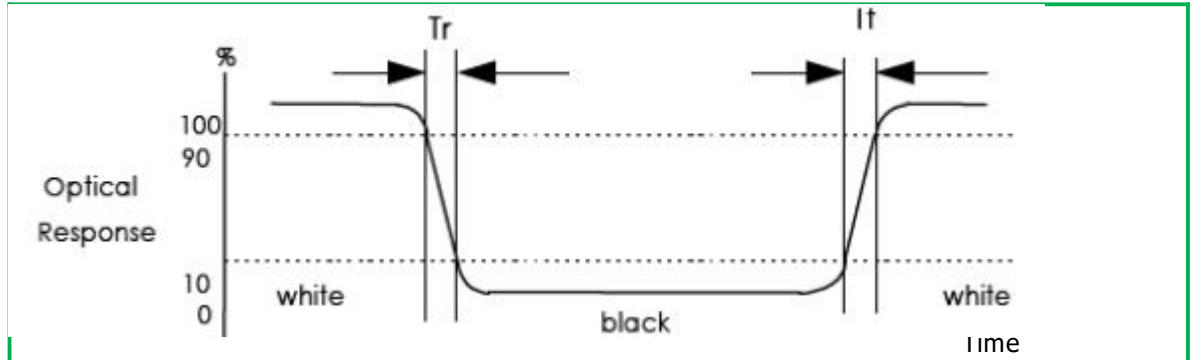

Figure 3. Response Time Testing



The electro-optical response time measurements shall be made as shown in FIGURE 3 by switching the “data” input signal ON and OFF. The times needed for the luminance to change from 10% to 90% is T_r and 90% to 10% is T_d .

9.0 MECHANICAL CHARACTERISTICS

9.0.1 Dimensional Requirements

<Table 9. Dimensional Parameters>

Parameter	Specification	Unit
Active Area	153.84 (H) × 85.632 (V)	mm
Number of pixels	800 (H) × 480(V)	
Pixel pitch	0.0641(H) × 0.1784(V)	mm
Pixel arrangement	RGB Vertical stripe	
Display colors	16.7M	colors
Display mode	Normally White	
Dimensional outline	164.9 (W)× 100(H)× 7.15(T)	
Weight	160	gram
Back-light	LED	

10.0 RELIABILITY TEST(ok)

The Reliability test items and its conditions are shown in below.

<Table 9. Reliability test>

NO	Test Items	Conditions
1	High temperature storage test	Ta = 80 °C , 240 hrs
2	Low temperature storage test	Ta = -30 °C , 240 hrs
3	High temperature & high humidity (operation test)	Ta = 60 °C , 90%RH, 240hrs
4	High temperature operation test	Ta = 70 °C , 240hrs
5	Low temperature operation test	Ta = -20 °C , 240hrs
6	Thermal shock	Ta = -30 °C ↔ 80 °C (0.5 hr), 100 cycle
7	ESD	C=150pF,R=330Ω,5point/搭配整机 B等级 contact ± 10kv ;Air ± 15kv

Note : After the reliability test, the product only guarantee function normally without any fatal defect (non-display, line defect, abnormal display etc). All the cosmetic specification is judged before the reliability test.

11.0 HANDLING & CAUTIONS

11.1 Mounting Method

- The panel of the LCD consists of two thin glasses with polarizers which easily get damaged. So extreme care should be taken when handling the LCD.
- Excessive stress or pressure on the glass of the LCD should be avoided. Care must be taken to insure that no torsional or compressive forces are applied to the LCD unit when it is mounted.
- If the customer's set presses the main parts of the LCD, the LCD may show the abnormal display. But this phenomenon does not mean the malfunction of the LCD and should be pressed by the way of mutual agreement.
- To determine the optimum mounting angle, refer to the viewing angle range in the specification for each model.
- Mount a LCD module with the specified mounting parts.

11.2 Caution of LCD Handling and Cleaning

- Since the LCD is made of glass, do not apply strong mechanical impact or static load onto it. Handling with care since shock, vibration, and careless handling may seriously affect the product. If it falls from a high place or receives a strong shock, the glass may be broken.
- The polarizers on the surface of panel are made from organic substances. Be very careful for chemicals not to touch the polarizers or it leads the polarizers to be deteriorated.
- If the use of a chemical is unavoidable, use soft cloth with solvent (recommended below) to clean the LCD's surface with wipe lightly.
-IPA(Isopropyl Alcohol), Ethyl Alcohol, Trichlorotrifluoroethane
- Do not wipe the LCD's surface with dry or hard materials that will damage the polarizers and others. Do not use the following solvent.
-Water, Ketone, Aromatics
- It is recommended that the LCD be handled with soft gloves during assembly, etc. The polarizers on the LCD's surface are vulnerable to scratch and thus to be damaged by sharp particles.
- Do not drop water or any chemicals onto the LCD's surface.
- A protective film is supplied on the LCD and should be left in place until the LCD is required for operation.
- The ITO pad area needs special careful caution because it could be easily corroded. Do not contact the ITO pad area with HCFC, Soldering flux, Chlorine, Sulfur, saliva or fingerprint. To prevent the ITO corrosion, customers are recommended that the ITO area would be covered by UV or silicon.

11.3 Caution Against Static Charge

- The LCD modules use C-MOS LSI drivers, so customers are recommended that any unused input terminal would be connected to Vdd or Vss, do not input any signals before power is turn on, and ground you body, work/assembly area, assembly equipments to protect against static electricity.
- Remove the protective film slowly, keeping the removing direction approximate 30-degree not vertical from panel surface, If possible, under ESD control device like ion blower, and the humidity of working room should be kept over 50%RH to reduce the risk of static charge.
- Avoid the use work clothing made of synthetic fibers. We recommend cotton clothing or other conductivity-treated fibers.
- In handling the LCD, wear non-charged material gloves. And the conducting wrist to the earth and the conducting shoes to the earth are necessary.

11.4 Caution For operation

- It is indispensable to drive the LCD within the specified voltage limit since the higher Voltage than the limit causes the shorter LCD's life. An electro-chemical reaction due to DC causes undesirable deterioration of the LCD so that the use of DC drive should avoid.
- Do not connect or disconnect the LCD to or from the system when power is on.
- Never use the LCD under abnormal conditions of high temperature and high humidity.
- When expose to drastic fluctuation of temperature (hot to cold or cold to hot) ,the LCD may be affected; Specifically, drastic temperature fluctuation from cold to hot ,produces dew on the LCD's surface which may affect the operation of the polarizer and the LCD.
- Response time will be extremely delayed at lower temperature than the operating temperature range and on the other hand at higher temperature LCD may turn black at temperature above its operational range. However those phenomena do not mean malfunction or out of order with the LCD. The LCD will revert to normal operation once the temperature returns to the recommended temperature range for normal operation.
- Do not display the fixed pattern for a long time because it may develop image sticking due to the LCD structure. If the screen is displayed with fixed pattern, use a screen saver.

11.5 Packaging

- Modules use LCD element, and must be treated as such.
 - Avoid intense shock and falls from a height.
 - To prevent modules from degradation, do not operate or store them exposed directly to sunshine or high temperature/humidity for long periods.

11.6 Storage

- A slight dew depositing on terminals is a cause for electro-chemical reaction resulting in terminal open circuit. Relative humidity of the environment should therefore be kept below 60%RH.
- Original protective film should be used on LCD's surface (polarizer). Adhesive type protective film should be avoided, because it may change color and/or properties of the polarizers.
- Do not store the LCD near organic solvents or corrosive gasses.
- Keep the LCD safe from vibration, shock and pressure.
- Black or white air-bubbles may be produced if the LCD is stored for long time in the lower temperature or mechanical shocks are applied onto the LCD.
- In the case of storing for a long period of time for the purpose or replacement use, the following ways are recommended.
 - Store in a polyethylene bag with sealed so as not to enter fresh air outside in it.
 - Store in a dark place where neither exposure to direct sunlight nor light is.
 - Keep temperature in the specified storage temperature range.
 - Store with no touch on polarizer surface by the anything else. If possible, store the LCD in the packaging situation LCD when it was delivered.

11.7 Safety

- For the crash damaged or unnecessary LCD, it is recommended to wash off liquid crystal by either of solvents such as acetone and ethanol an should be burned up later.
- In the case the LCD is broken, watch out whether liquid crystal leaks out or not. If your hands touch the liquid crystal, wash your hands cleanly with water an soap as soon as possible.
- If you should swallow the liquid crystal, first, wash your mouth thoroughly with water, then drink a lot of water and induce vomiting, and then, consult a physician.
- If the liquid crystal should get in your eyes, flush your eyes with running water for at least fifteen minutes.
- If the liquid crystal touches your skin or clothes, remove it and wash the affected part of your skin or clothes with soap and running water.

12.0 MECHANICAL OUTLINE DIMENSION

Figure 4. TFT-LCD Module Outline Dimension (Front View)

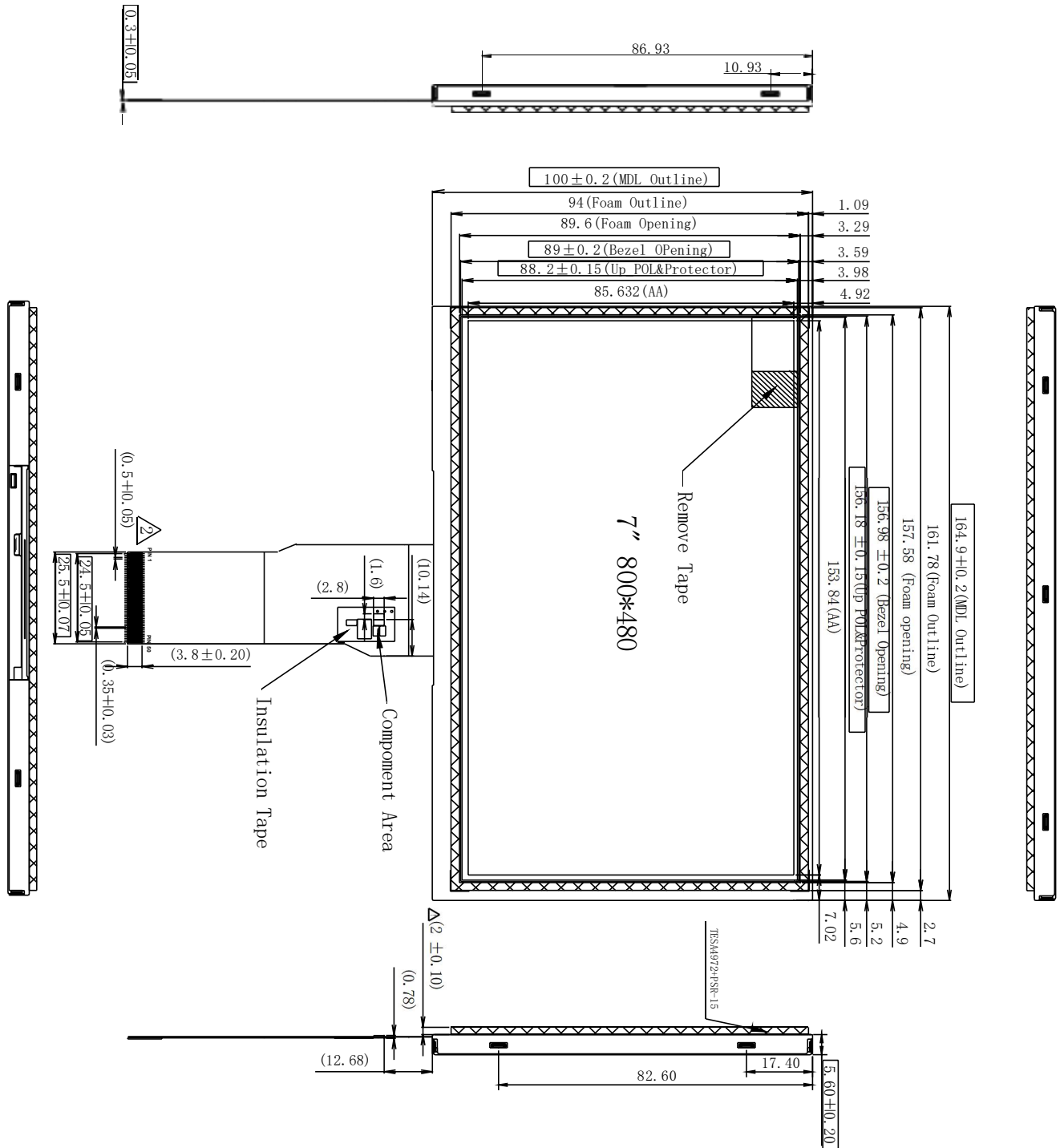

Figure 5. TFT-LCD Module Outline Dimensions (Rear view)

